

TENDE A BRACCI CON CASSONETTO

Cassette folding arm awnings
Store coffre

Hülsen- und Kassettenmarkisen
Toldos de brazos extensibles con cofre

ARMONY PLUS



awning the Italian way



ARMONY PLUS

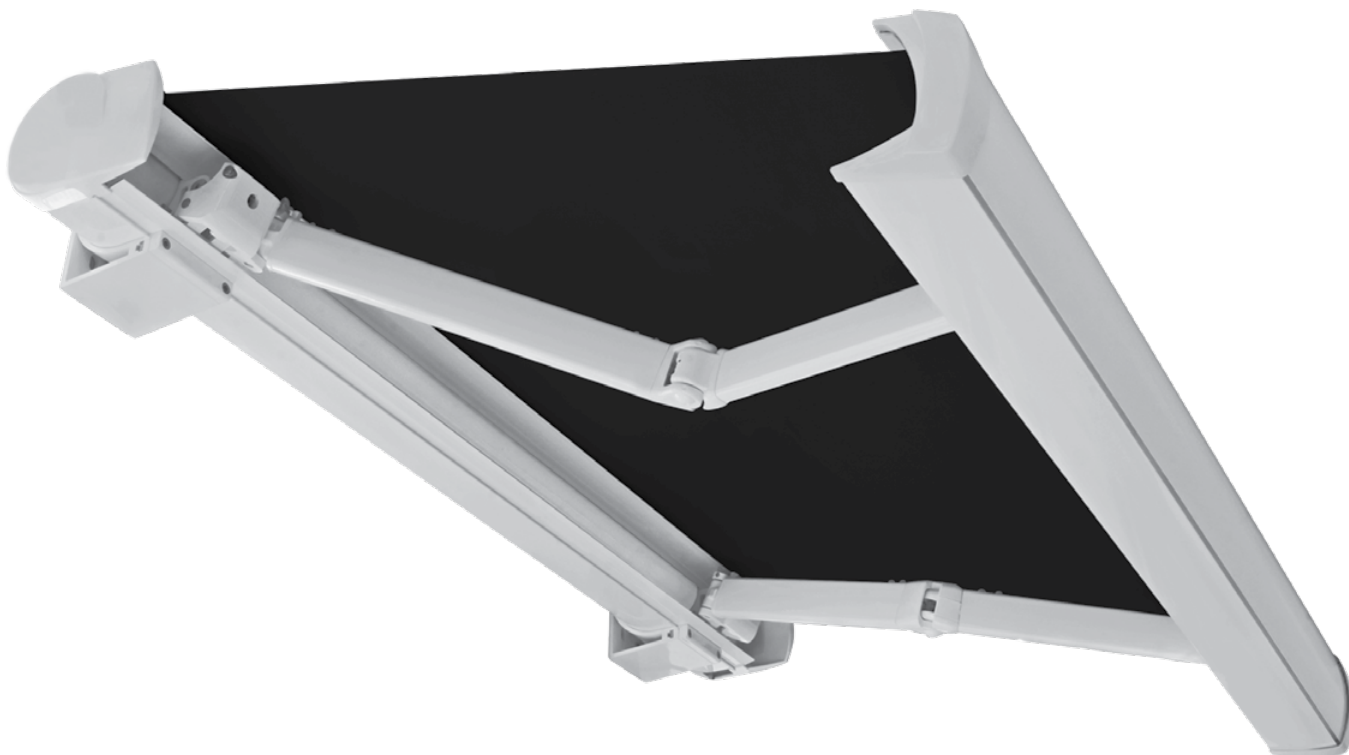

ARMONY PLUS è una tenda a bracci estensibili con cassonetto a scomparsa totale. Nuovo design e nuovo stile uniti alla funzionalità e alla tecnologia di un sistema ribaltabile BAT che permette la chiusura ermetica del cassonetto anche nella sua massima inclinazione inoltre, grazie ad un profilo di guarnizione il cassonetto risulta essere perfettamente aderente al muro impedendo l'infiltrazione di acque ed impurità.



ARMONY PLUS is a fully cassetted folding arm awning. New design and restyled added to the function and technology of a BAT flipping system that allows the complete and hermetical closure of the box even at the maximum inclination. More of that, thanks to a gasket profile, the box will be closed to the wall and will avoid water and impurities penetration.



ARMONY PLUS est un store coffre integral. Nouveau design et nouveau style unis à la fonction et technologie d'un système renversable BAT qui permet la fermeture hermétique du coffre même dans le cas d'une inclinaison maxi, entre autre, grace à son profil de butée le coffre sera complètement adhérent au mur en évitant l'infiltration d'eau et impurités.



ARMONY PLUS ist eine Hochwertige Kassettenmarkise. Neues Design und neuer Stil zusammen mit der Zweckdienstlichkeit eines Kipparmgelenk, mit dem das perfekte Schliessen der Kasette auch bei maximaler Neigung leisten kann. Ausserdem, dank eines neuen Dichtungsprofils, ist die Kassettenmarkise perfekt an der Wand befestigt, so dass es kein Wasser oder Schmutz von der hinteren Seite eindringen kann.



ARMONY PLUS es un toldo cofre de brazos extensibles con cierre total. Nuevo diseño y nuevo estilo unidos a la funcionalidad y a la tecnología del sistema abatible BAT que permite el cierre hermético del cofre incluso en el caso de inclinaciones máximas. Por otra parte, y gracias a un perfil complementario, el cajón puede estar totalmente pegado a la pared impidiendo la filtración de agua y suciedad.

SCHEMA TECNICA

technical sheet



Montaggio a parete
Wall installation



Montaggio a soffitto
Ceiling installation



Montaggio sottotetto
Under-roof installation

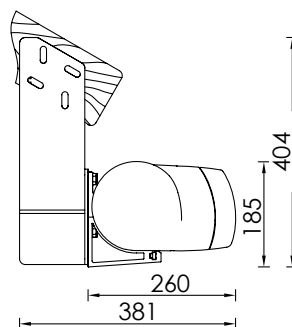
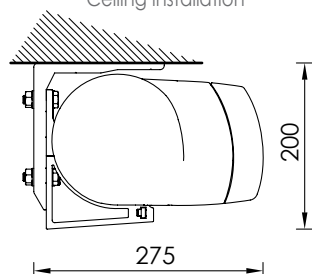
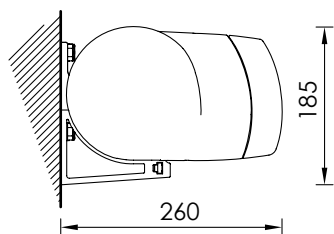

Montaggio a parete
con terminale a cassonetto*
Wall installation with box
front bar*

Montaggio a soffitto
con terminale a cassonetto*
Ceiling installation with box
front bar*

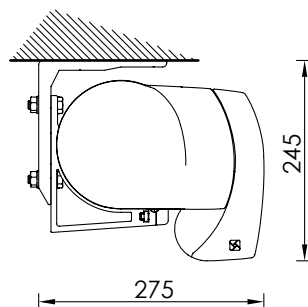
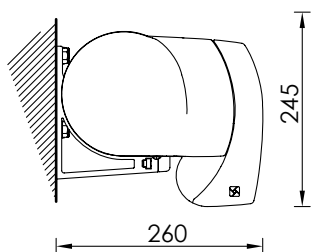

Dimensioni massime - Maxi dimensions

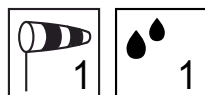
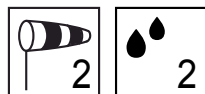
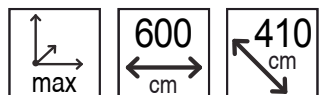
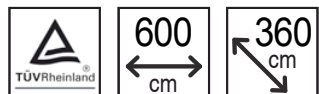

Con terminale a cassonetto -
With box front bar

Ingombri minimi della tenda finita - 1 coppia bracci
Minimum awning encumbrances - 1 pair arms
Encombrents minimum du store fini - 1 pair bras
Mindestabmessungen der Markise - 1 Paar Gelenkarme
Tamaño mínimo del toldo - 1 pareja de brazos

Sporgenza Projection Avancée Ausladung Salida	Larghezza min. Min. Width Largeur min. Breite min. Línea mín.
160	212
185	237
210	262
235	287
260	312
285	337
310	374
335	399
360	424
385	444
410	474



* Max 500x310 con braccio forgiato
 * Max 500x310 with forged arm

Diagramma di copertura - Installazione parete e soffitto - Covering diagram - Wall and ceiling installation

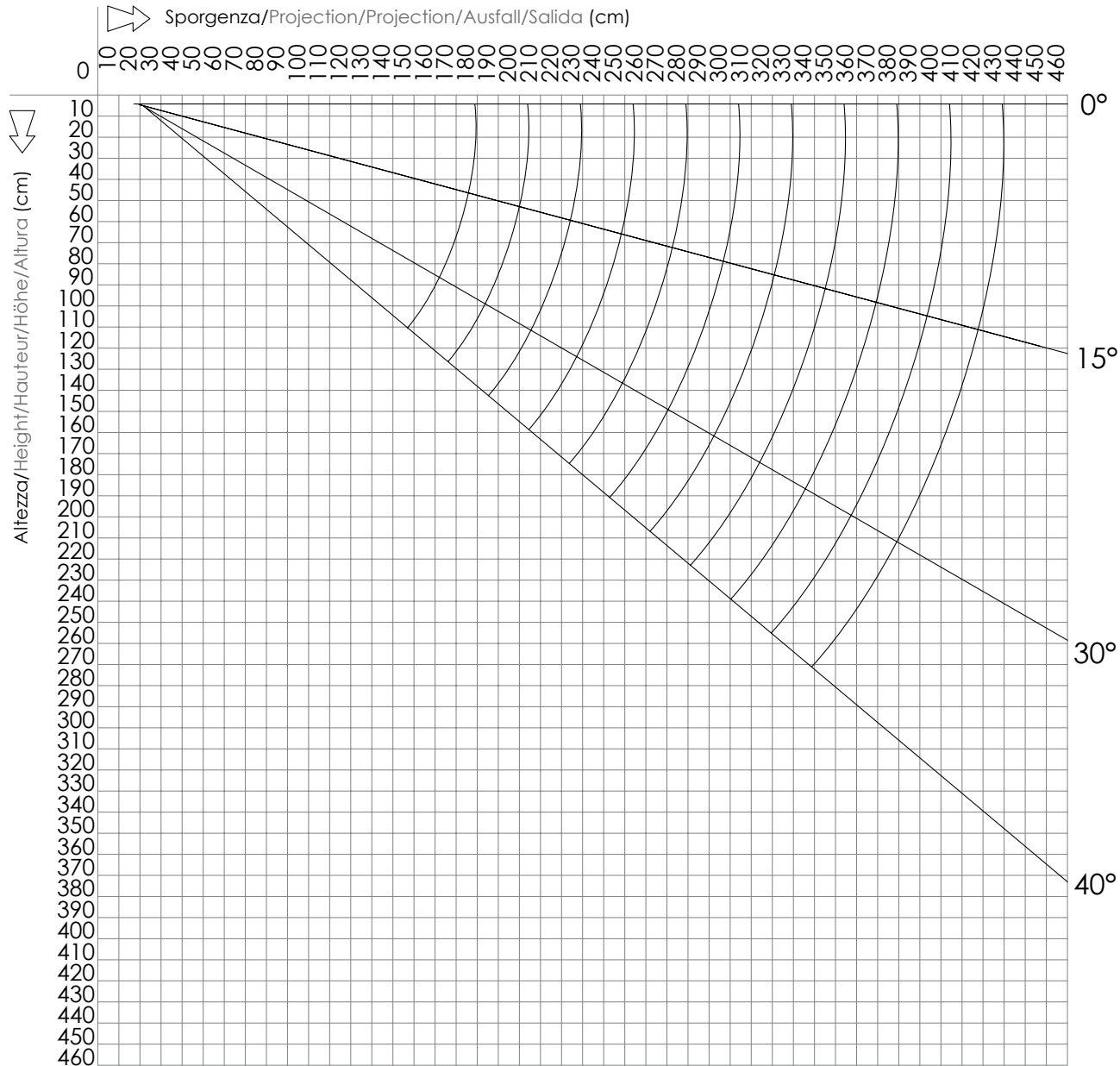



awning the Italian way

BAT S.p.A.

Via H. Ford - Z.I. Est
30020 Noventa di Piave (VE) - Italy
T. +39 0421 65672
F. +39 0421 659007
www.batgroup.com - info@batgroup.com

BAT FRANCE

Quartier des 4 Chemins
Zac Ducournau
83340 Flassans Sur Issole
Tel 04 94 78 17 73
Fax 04 94 04 79 32
www.batgroup.com - info@batgroup.fr

BAT IBÉRICA, S.L.

Travesia Cuenca-3, núm.2
Pol. Ind. Camporosso
Apartado de Correos nº 22
02520 Chinchilla de Monte Aragón (Albacete)
T. +34 967 261 779 - F. +34 967 261 584
www.batgroup.com - info@batiberica.es

BAT USA CORP.

Head offices
445 Bellvale Road
Chester, NY 10918
Phone 845 610 1139
Fax 845 610 1120
www.batgroup.com - info@batusa.us